



Product of Australia

Instruments

Activity Book

Trace them

Colour them in

Write about them using

NSW foundation

handwriting style

- | | |
|---------------|------------------------|
| 1. Harp | 11. Bouzouki |
| 2. Ukulele | 12. Yehu |
| 3. Violin | 13. Wheelharp |
| 4. Balalaika | 14. Xiqin |
| 5. Guitar | 15. Mandolin |
| 6. Banjo | 16. Viola |
| 7. Sitar | 17. Guqin |
| 8. Fiola | 18. Erhu |
| 9. Waldzither | 19. Detective's Corner |
| 10. Dulcimer | |

Copyright © Beatrice Wilder 2022
Published in 2022 by **Music Fun**
19 Millyard Lane, Katoomba 2780
P.O. Box 342 Katoomba 2780

Phone: 0438 439 984
02 4782 3073

Email: info@musicfun.net.au
Web: www.musicfun.net.au

Please feel free to contact us with any questions about the copying and use of our worksheets in your school as well as information about Australia's current copyright provisions governing educational institutions.

Nearly all of our schools have licenses allowing them to copy and communicate material from our worksheets. If in doubt, please ask us.



Stringed Instruments

1. Harp

Name

Trace and colour the ...

Harp

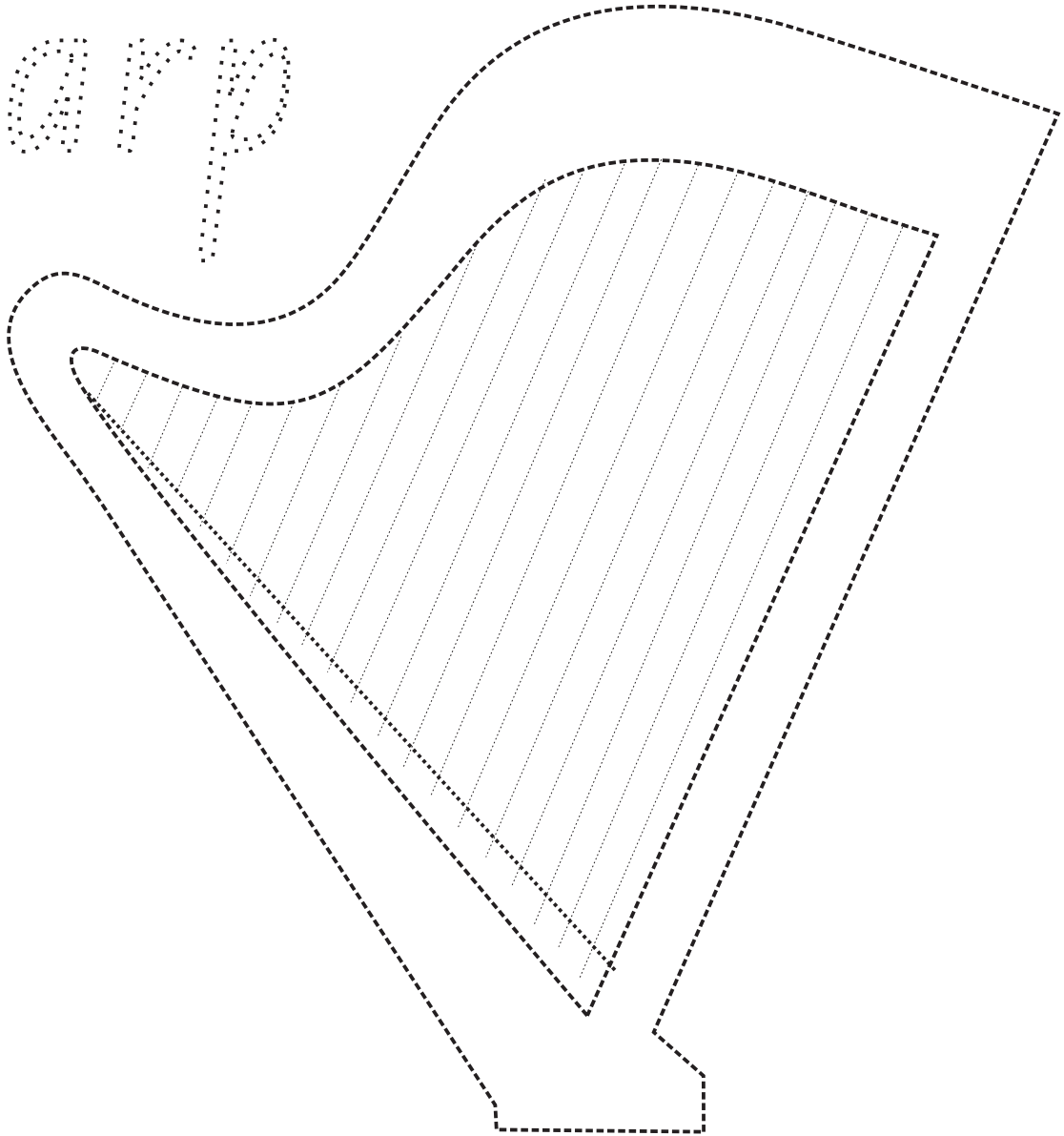

Play my strings with your fingers.





Stringed Instruments

2. Ukulele

Name

Trace and colour the ...

Ukulele

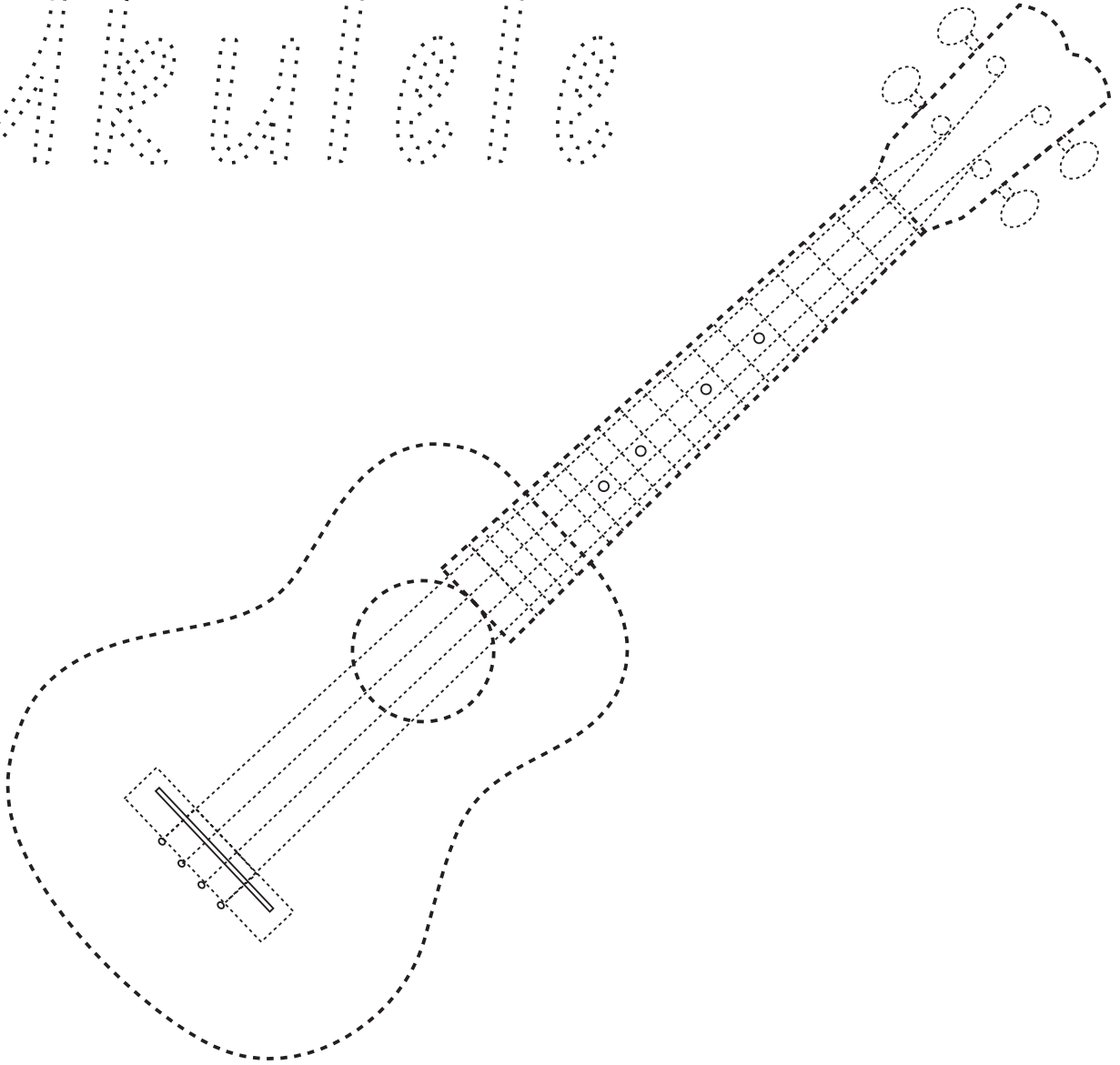

I look like a tiny guitar.

.....
.....
.....



Stringed Instruments

3. Violin

Name

Trace and colour the ...

Violin

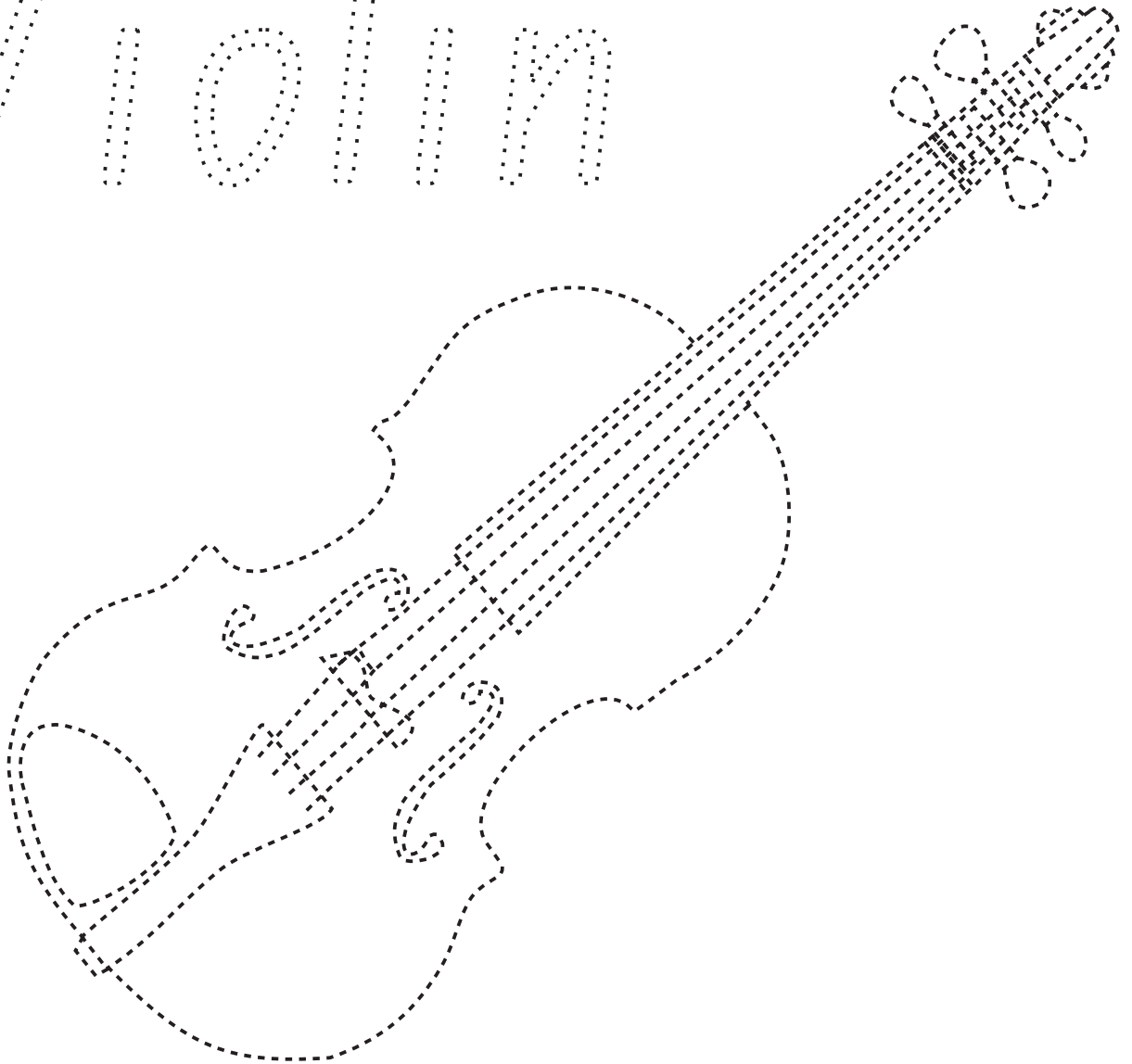

I can also be called a fiddle.

.....
.....
.....



Stringed Instruments

4. Balalaika

Name

Trace and colour the ...

Balalaika

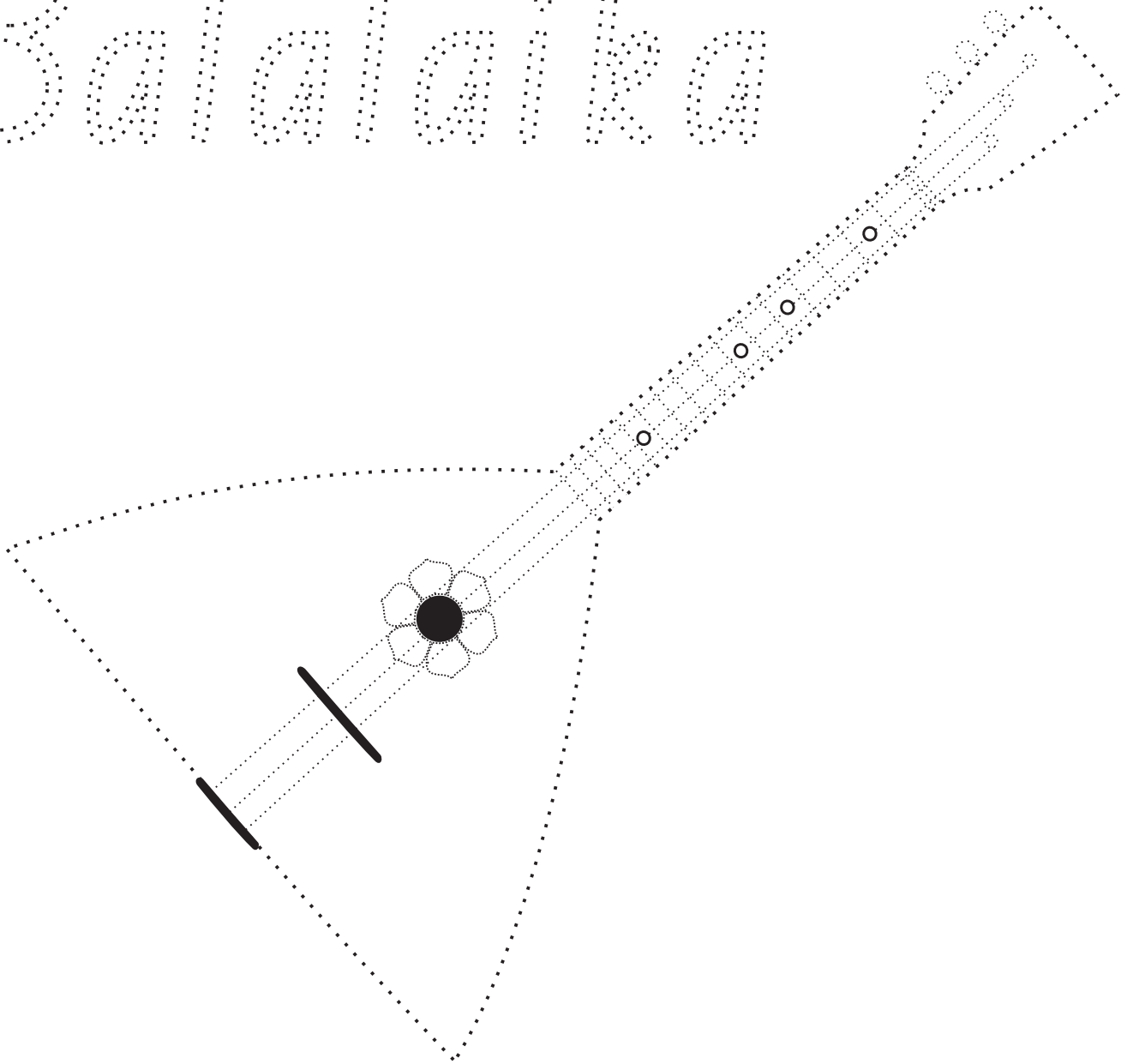

Traditional Russian instrument.





Stringed Instruments

5. Guitar

Name

Trace and colour the ...

Guitar

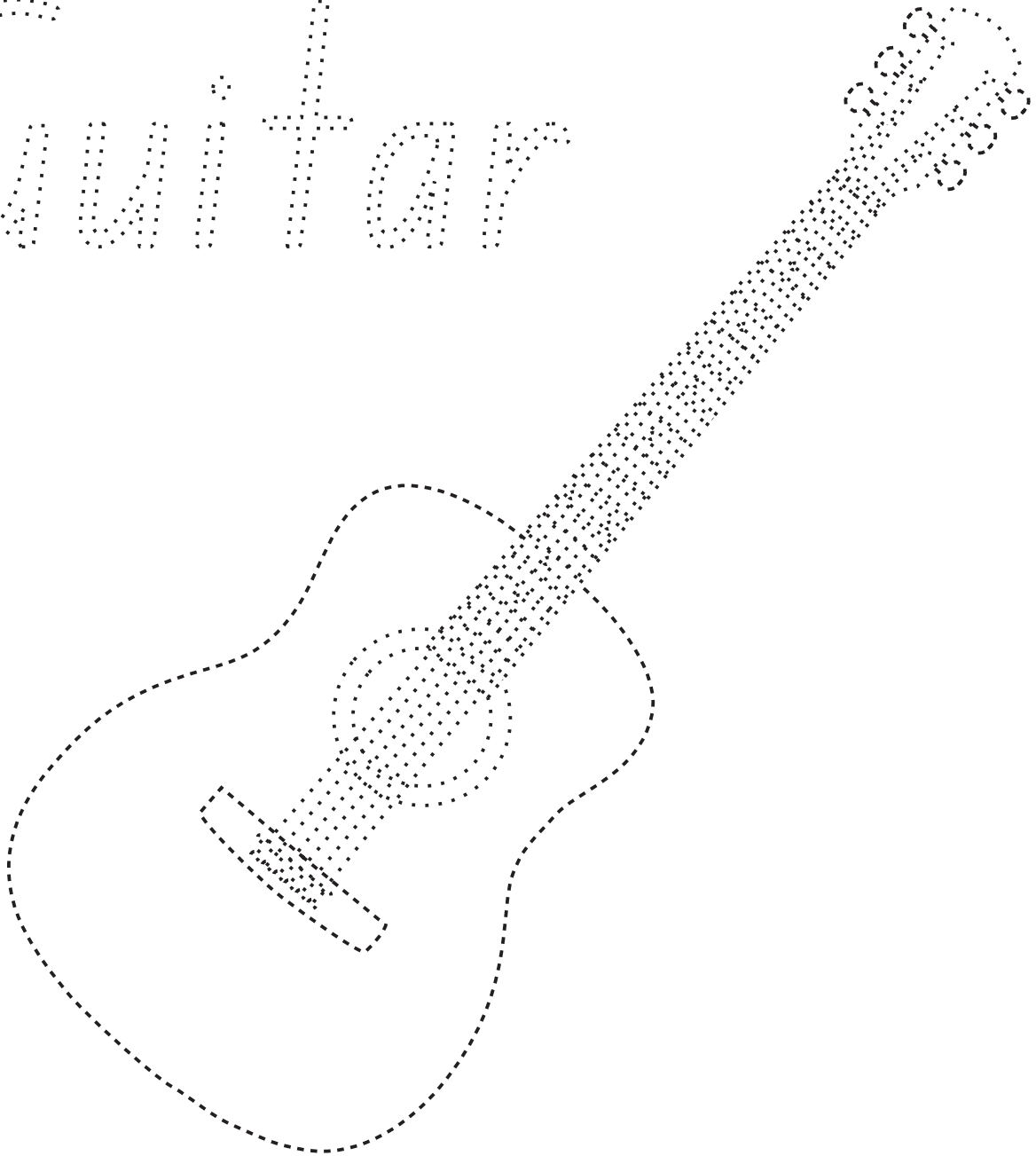

Most guitars have six strings.

.....
.....
.....



Stringed Instruments

6. Banjo

Name

Trace and colour the ...

Banjo

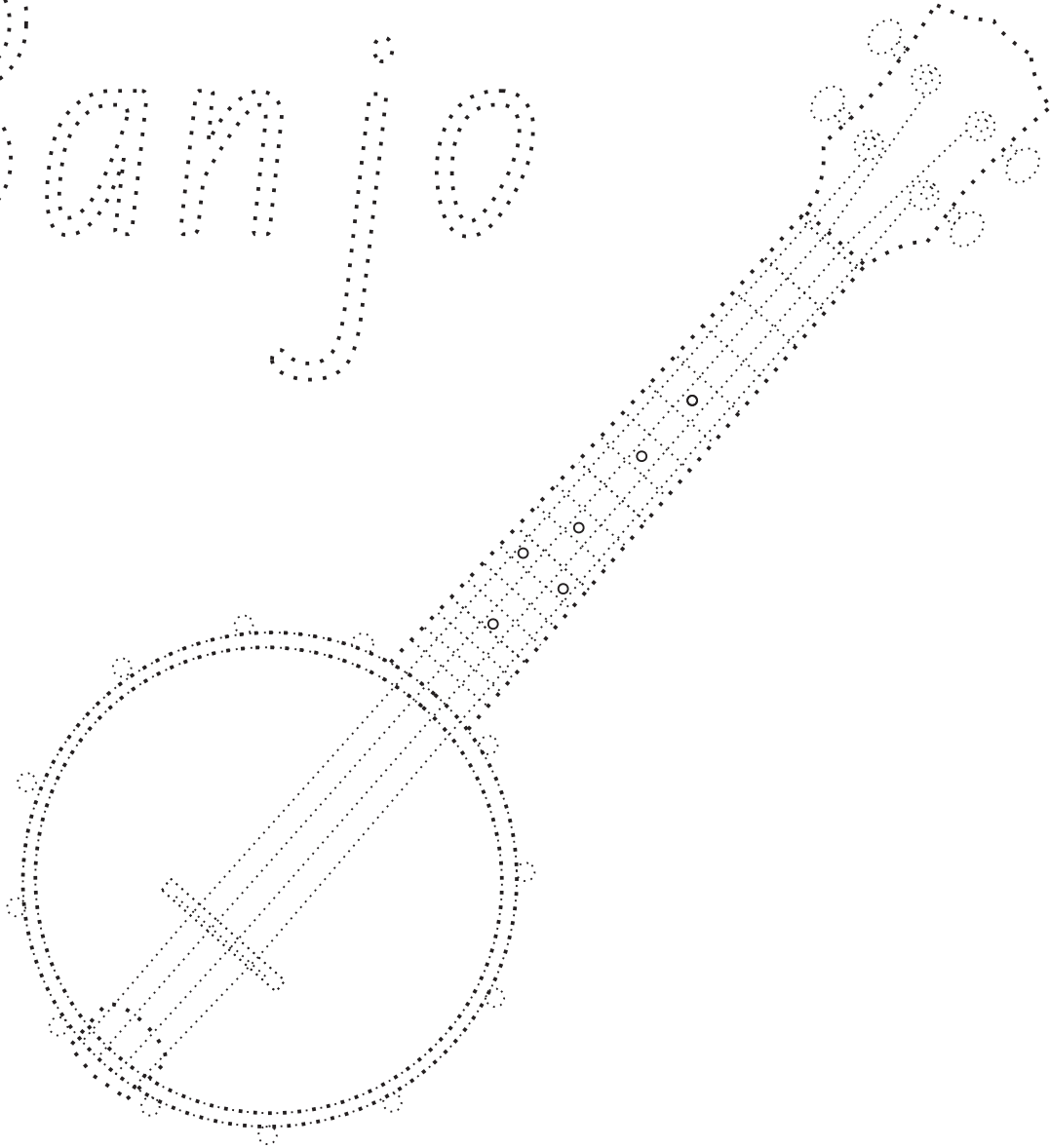

I love playing bluegrass music.





Stringed Instruments

7. Sitar

Name

Trace and colour the ...

Sitar

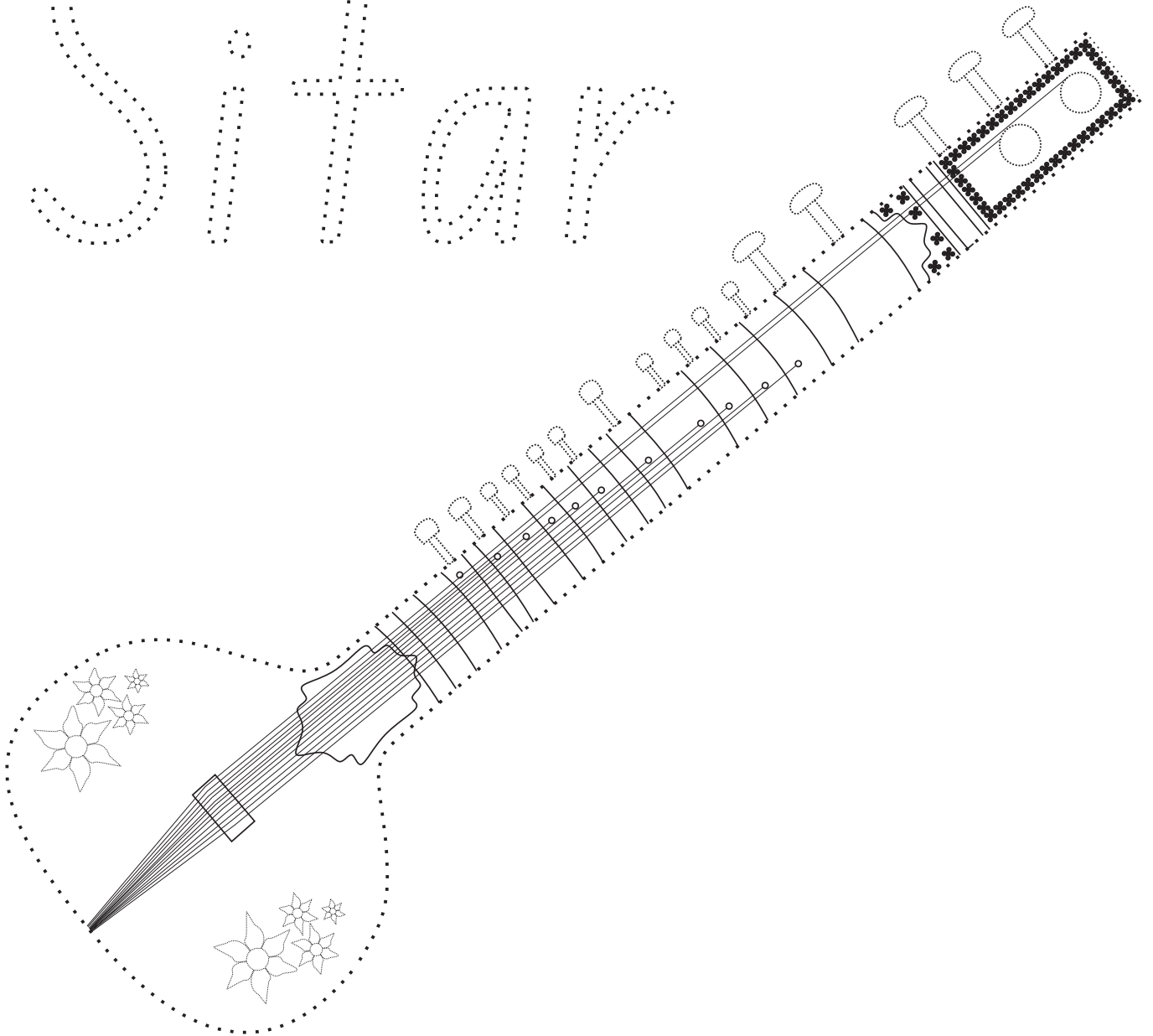

A plucked stringed instrument.





Stringed Instruments

8. Fiola

Name

Trace and colour the ...

Fiola

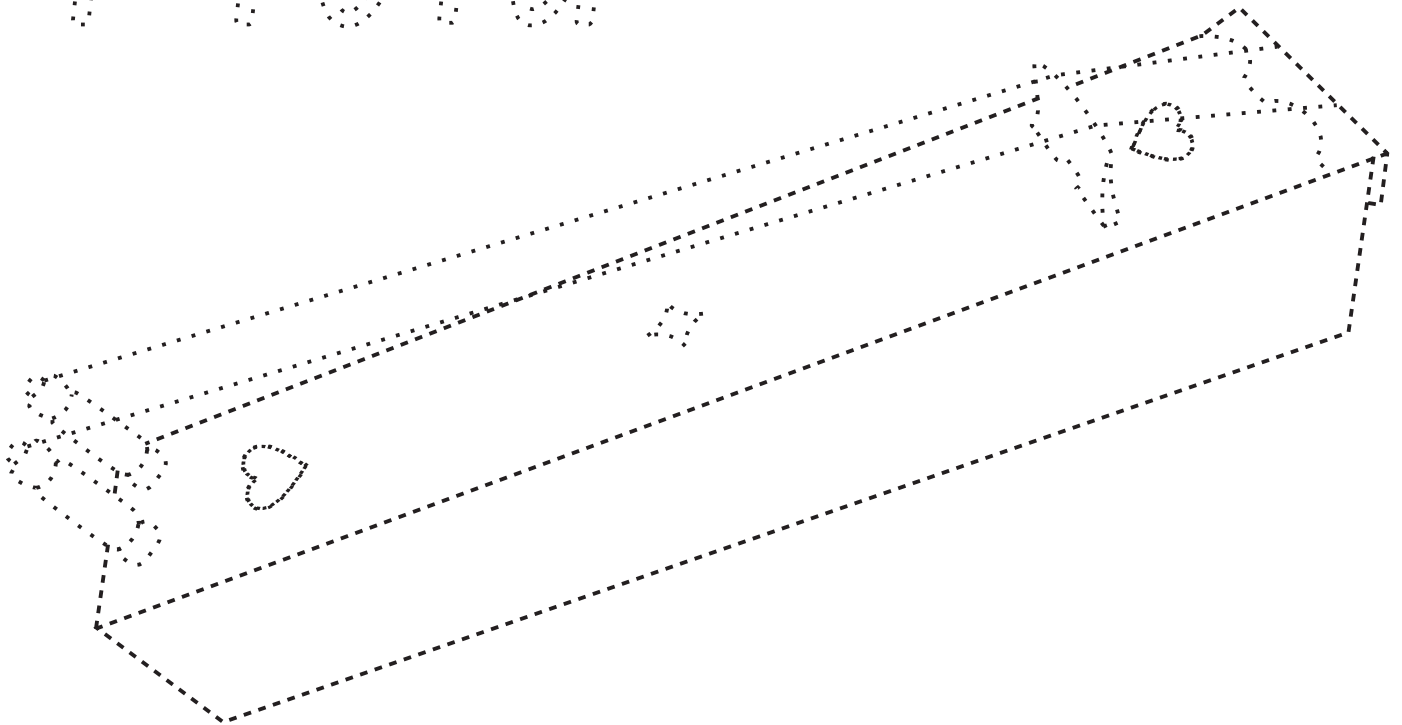

I am an Icelandic Fiddle.





Stringed Instruments

9. Waldzither

Name

Trace and colour the ...

Waldzither

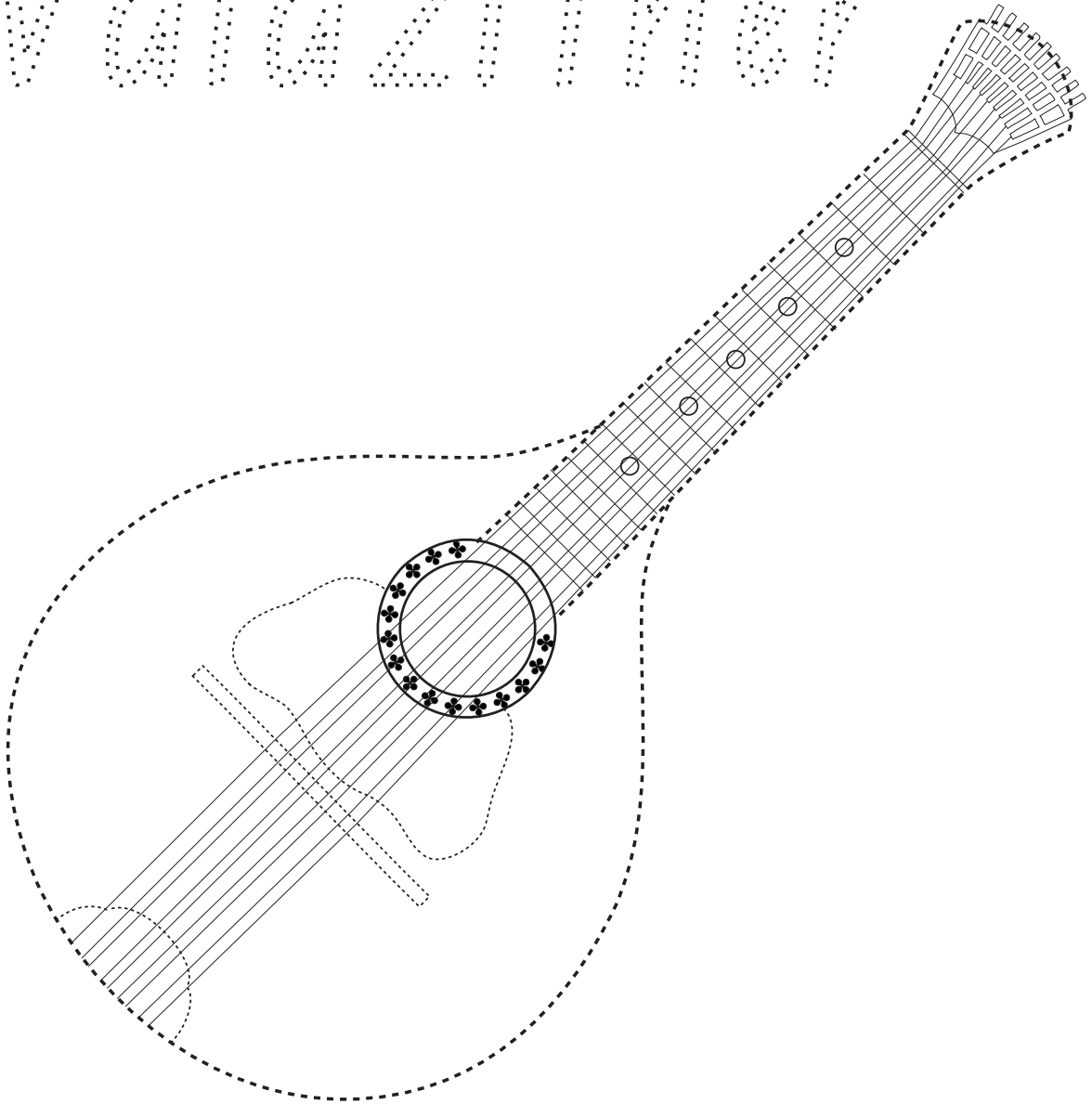

I am a Forest Zither

.....
.....
.....



Stringed Instruments

10. Dulcimer

Name

Trace and colour the ...

Dulcimer

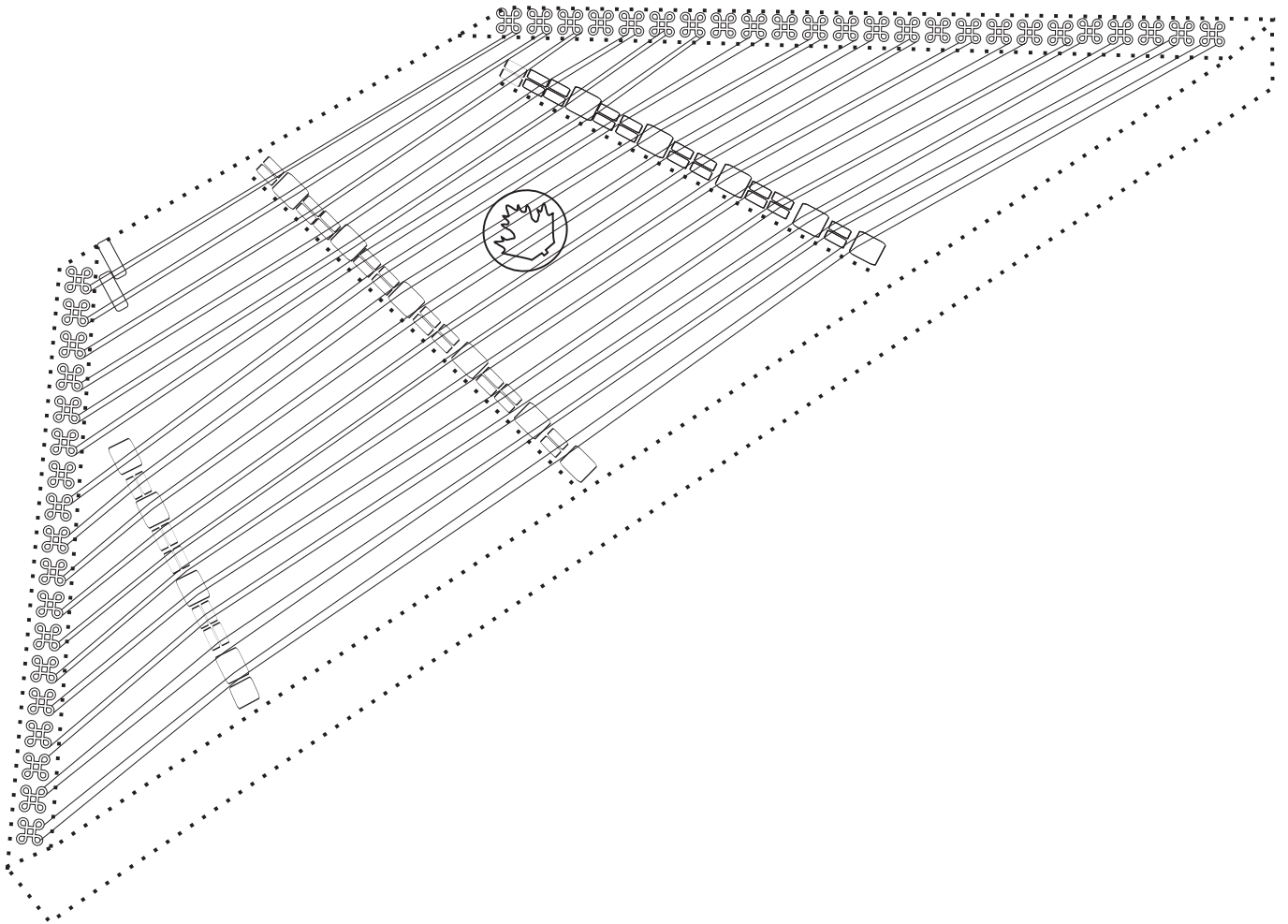

I come in many styles.

.....
.....
.....



Stringed Instruments

11. Bouzouki

Name

Trace and colour the ...

Bouzouki

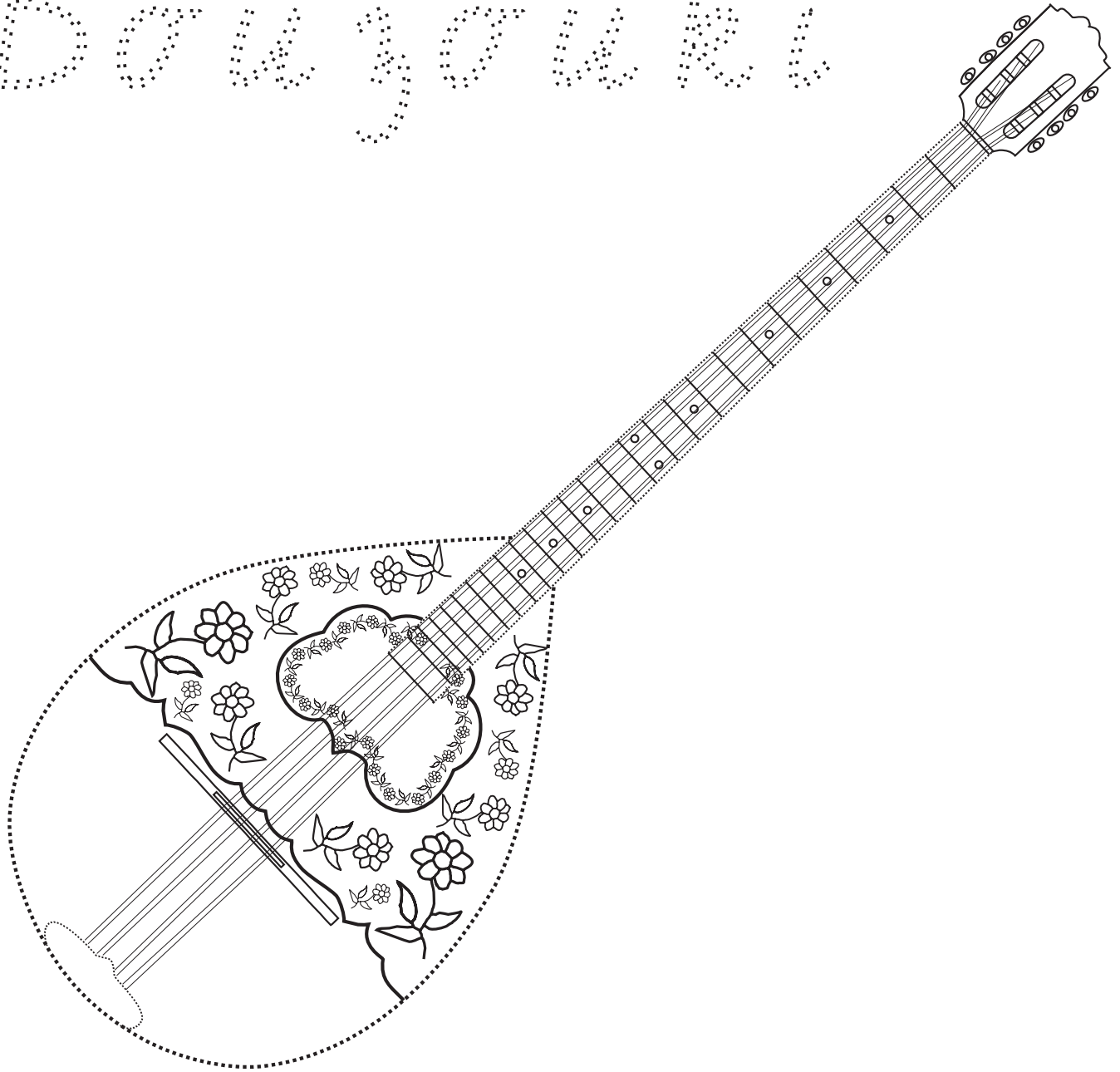

Has its strings in pairs.

.....
.....
.....



Stringed Instruments

12. Yehu

Name

Trace and colour the ...

Yehu

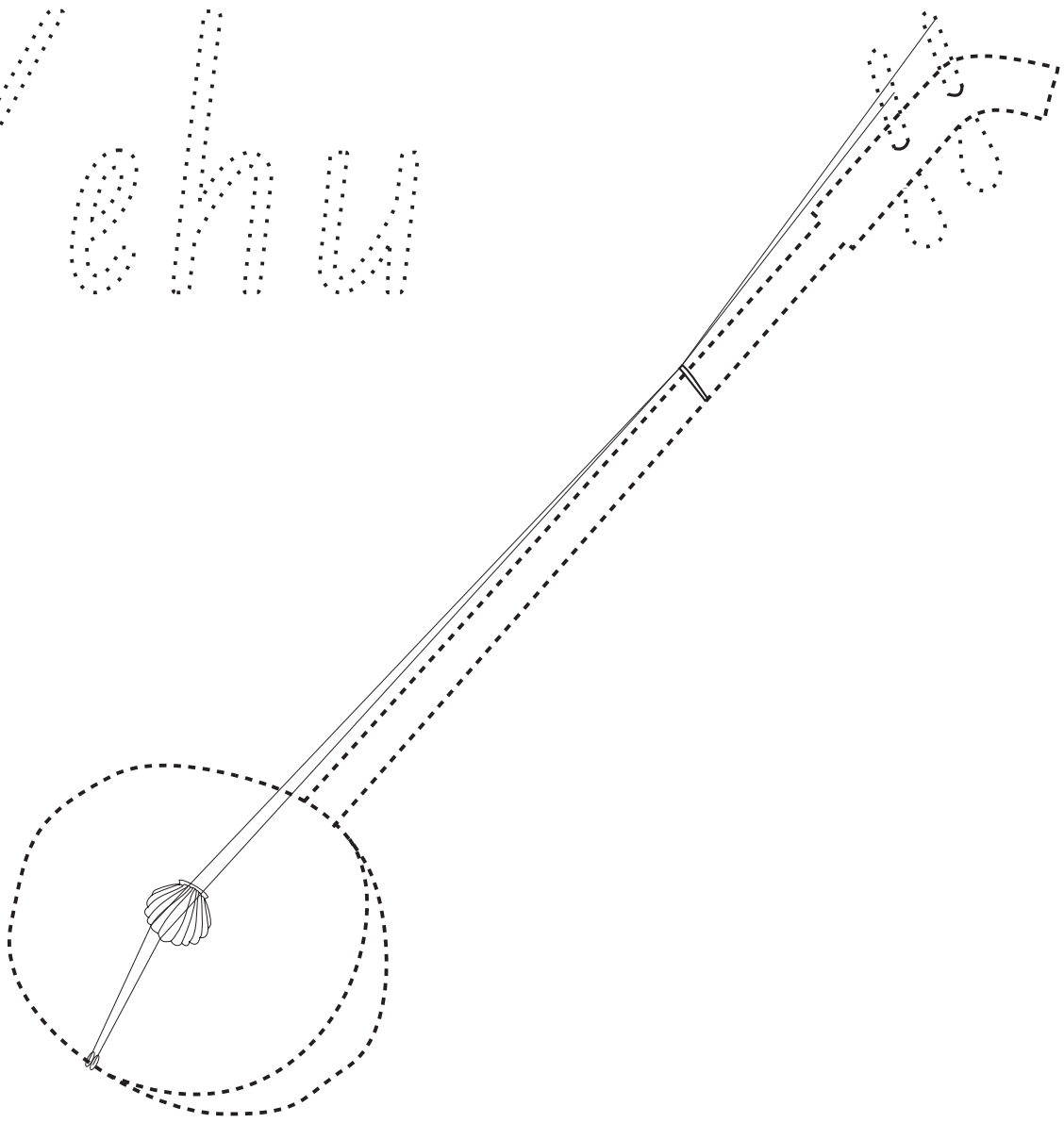

I am made from a coconut.

.....
.....
.....



Stringed Instruments

13. Wheelharp

Name

Trace and colour the ...

Wheelharp

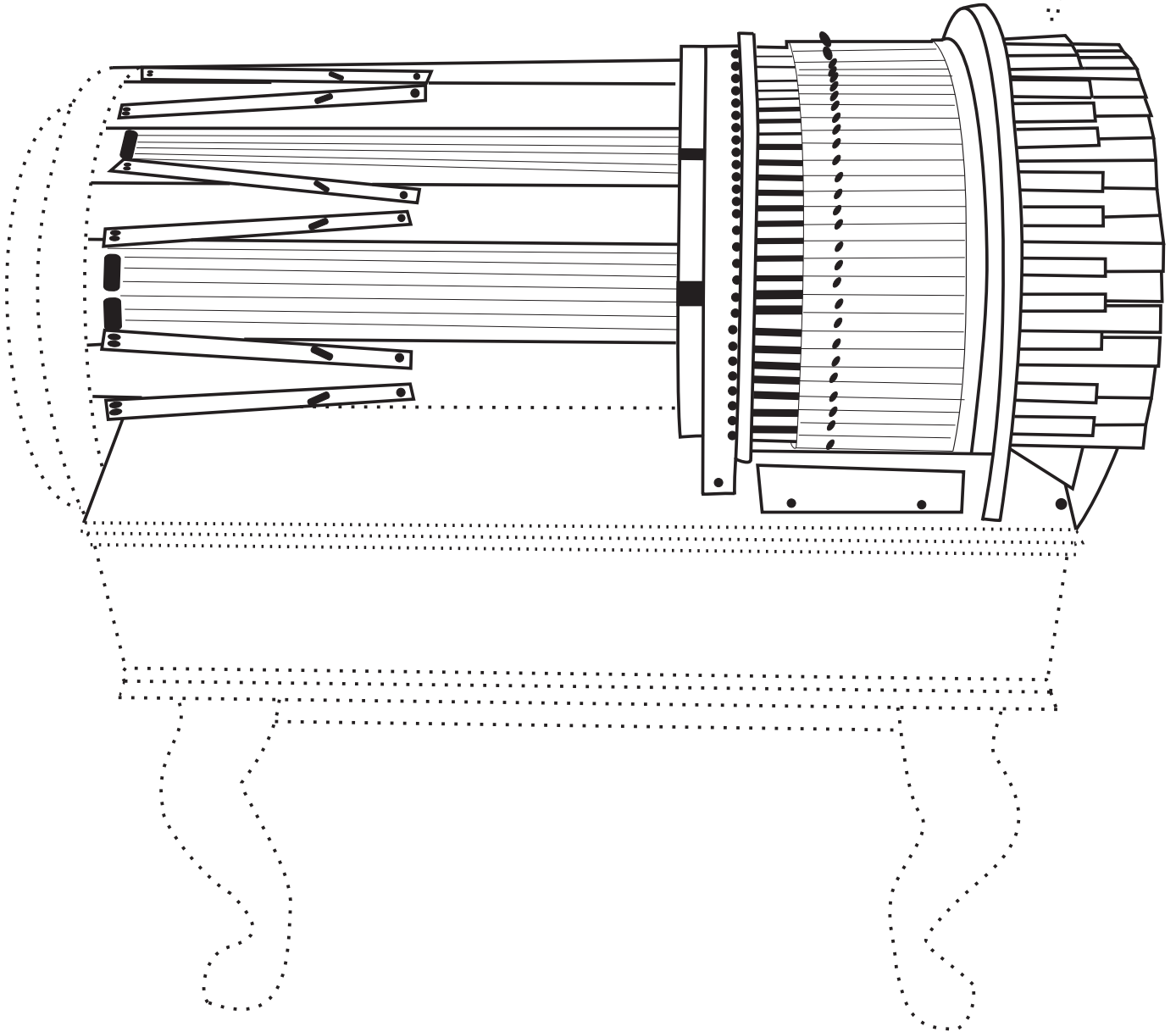

Has a keyboard and foot controlled motor.

.....
.....
.....



Stringed Instruments

14. Xiqin

Name

Trace and colour the ...

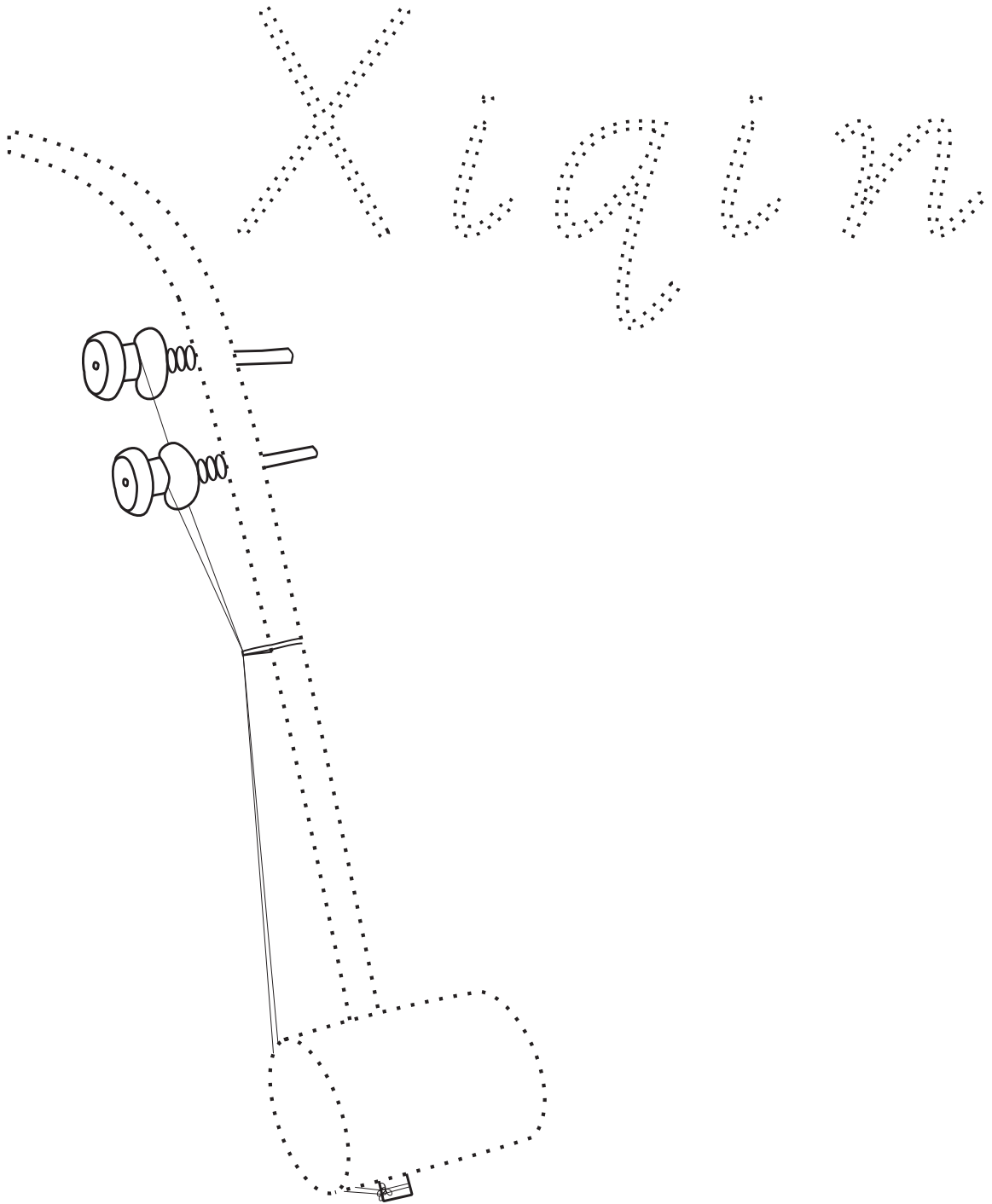

Chinese instrument with 2 silk strings.

.....
.....
.....



Stringed Instruments

15. Mandolin

Name

Trace and colour the ...

Mandolin

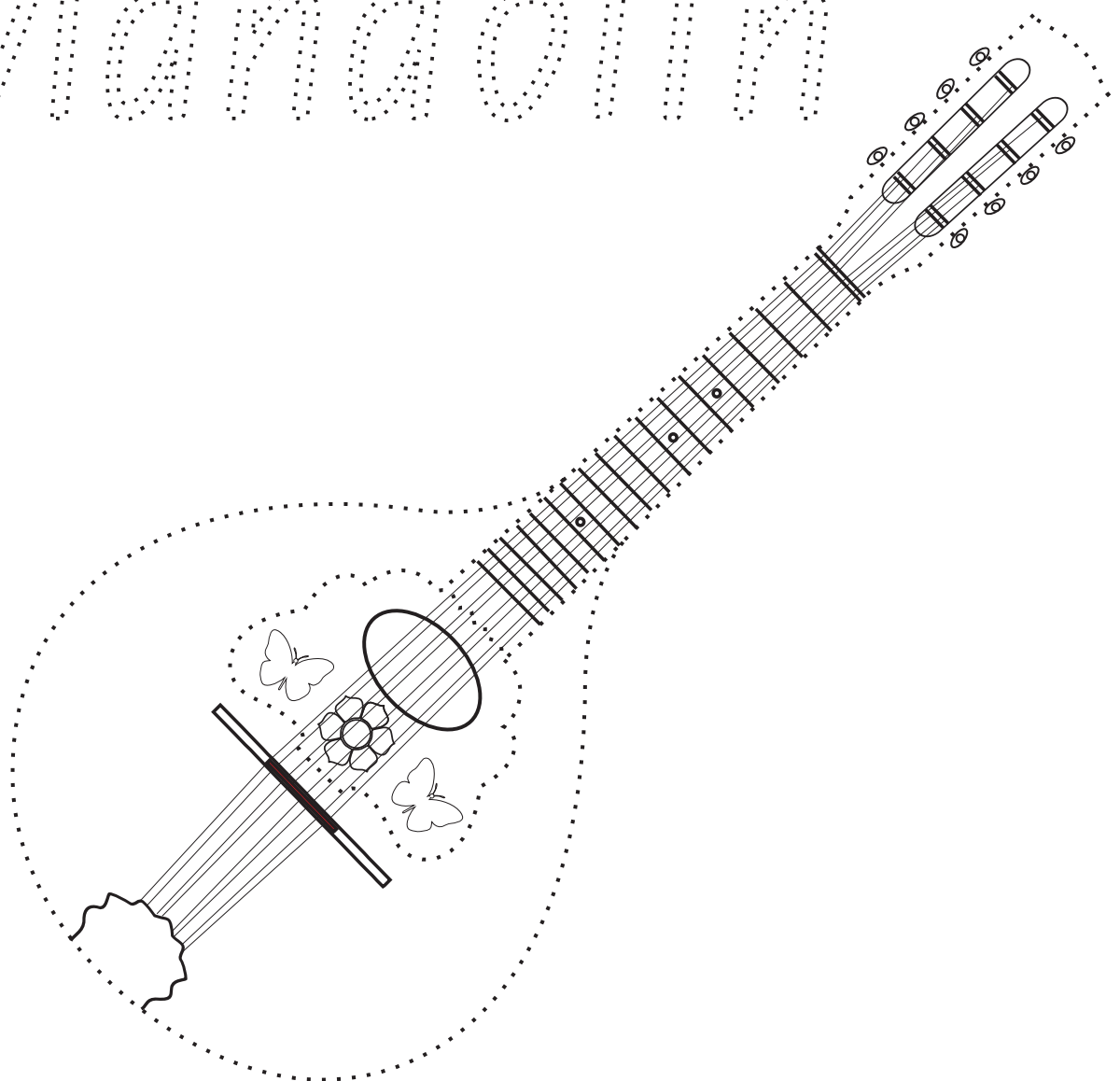

I belong to the lute family.

.....
.....
.....



Stringed Instruments

16. Viola

Name

Trace and colour the ...



A little bigger than a violin.

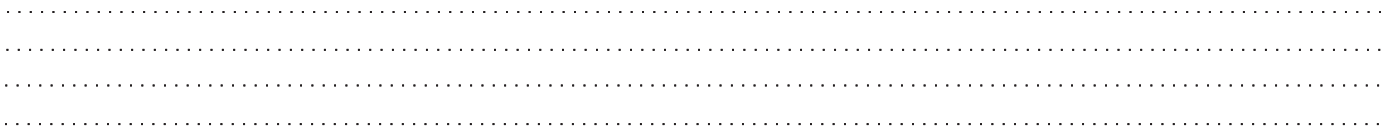



Stringed Instruments

17. Guqin

Name

Trace and colour the ...

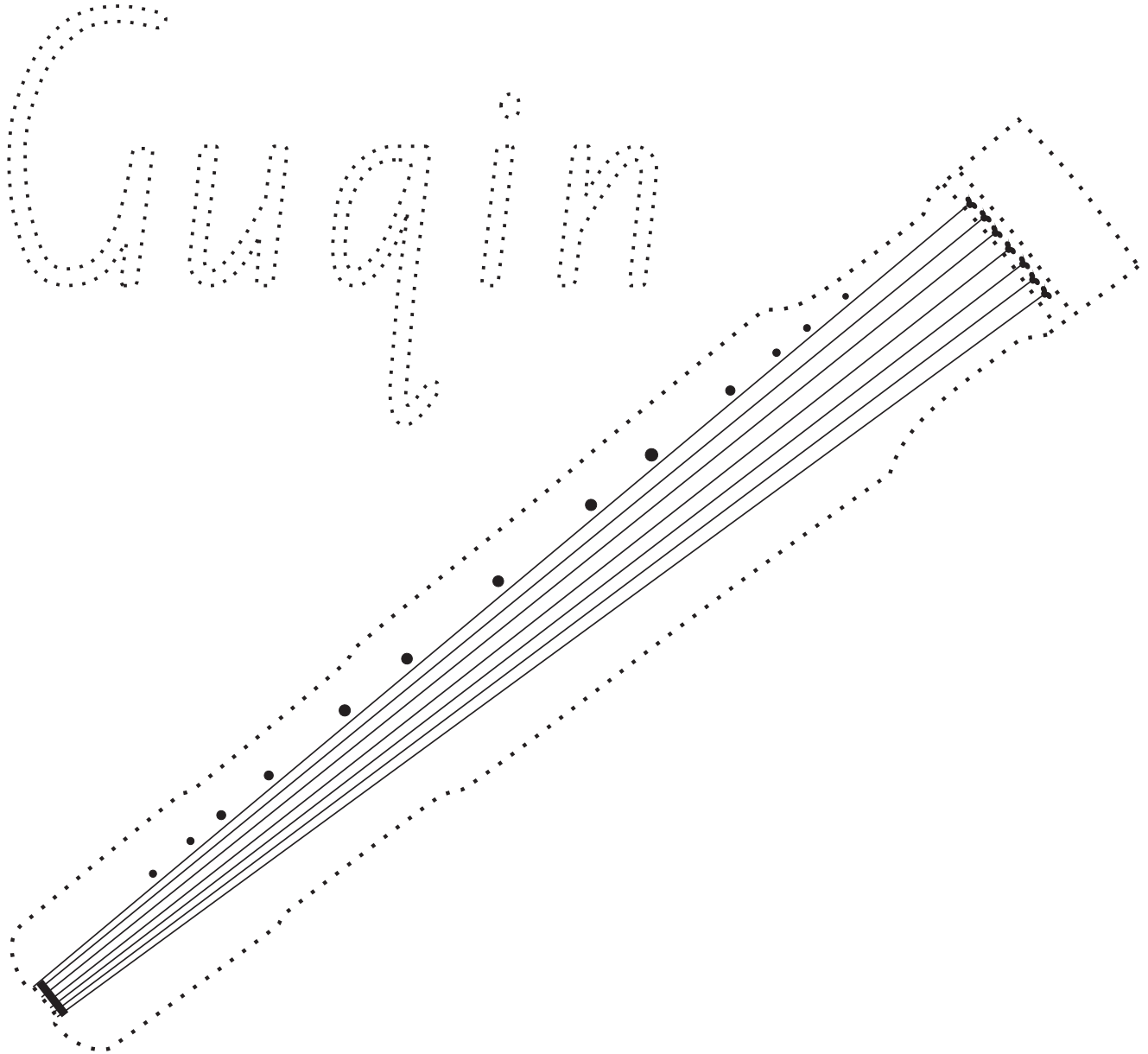

An ancient Chinese instrument.

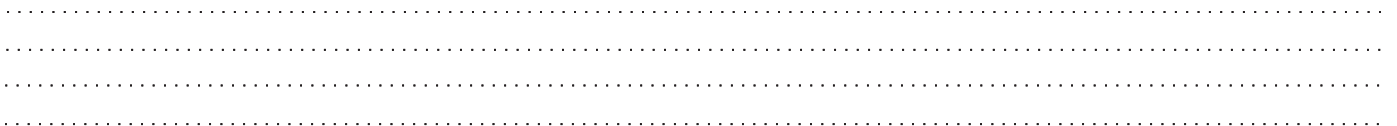



Stringed Instruments

18. Erhu

Name

Trace and colour the ...

Erhu

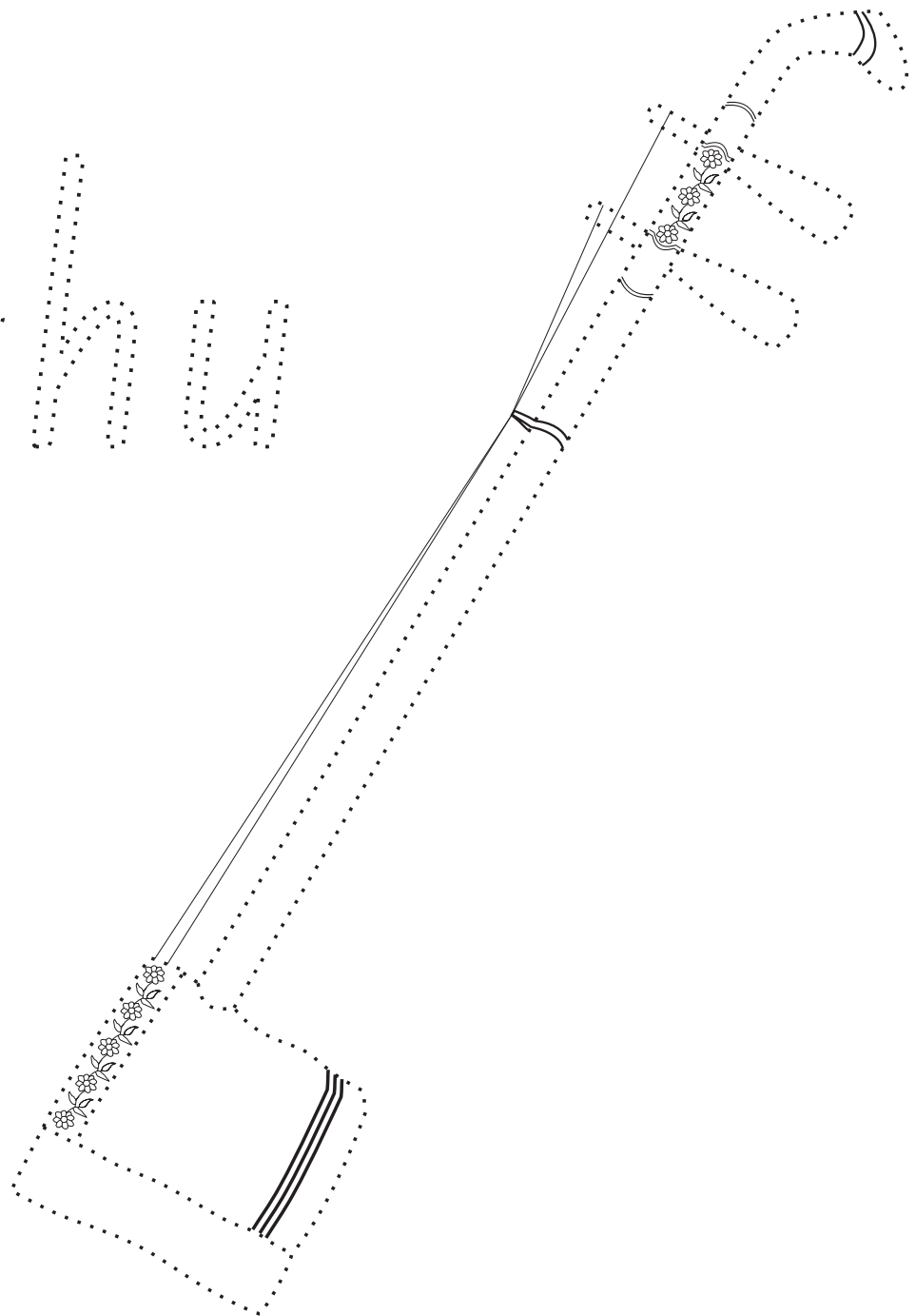

Also known as a Chinese violin.













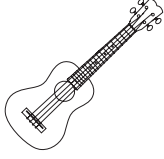



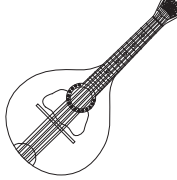

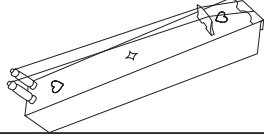

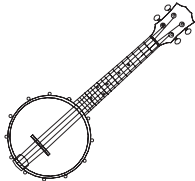

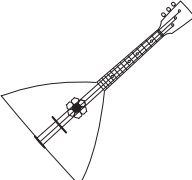



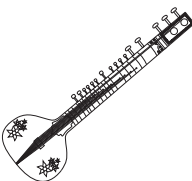

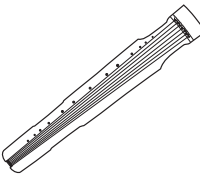

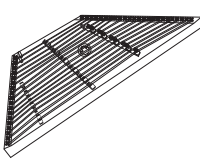



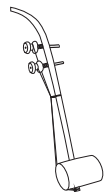

.....
.....
.....

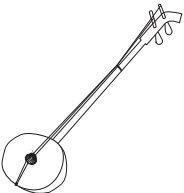

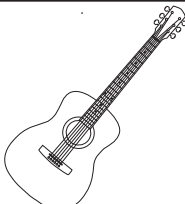
Stringed Instruments

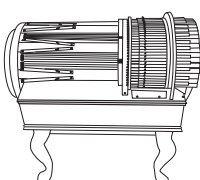
19. Detective's Corner

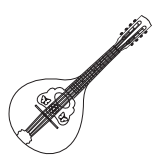
Name

 <p>I have many strings in a frame, you can play me by plucking or strumming them with your fingers.</p>  <p>_____</p>	 <p>My home is an island and I love to play with hula dancers</p>  <p>_____</p>
 <p>I am sometimes called a fiddle, you would play me with a bow.</p>  <p>_____</p>	 <p>I come from Germany and am named for the forest. I have nine strings.</p>  <p>_____</p>
 <p>I am a traditional instrument from Iceland with 2 strings. You would play me with a bow.</p>  <p>_____</p>	 <p>I have a membrane stretched over a frame and a resonator.</p>  <p>_____</p>
 <p>I come from Russia. I have a triangular body and 3 strings.</p>  <p>_____</p>	 <p>I come from Greece. I have 6 or 8 strings in pairs.</p>  <p>_____</p>
 <p>I can have up to 21 strings. I have curved frets and tuning pegs along my hollow neck.</p>  <p>_____</p>	 <p>I have 7 strings which you play by plucking. I come from China.</p>  <p>_____</p>
 <p>I come in many shapes and types. This type is played with little hammers.</p>  <p>_____</p>	 <p>I come from China. I only have 2 strings and you would play me with a bow.</p>  <p>_____</p>
 <p>I am very much like a violin only a little bigger and I have a deeper, richer sound.</p>  <p>_____</p>	 <p>I have 2 strings and am held vertically. I used to be bowed with a bamboo stick.</p>  <p>_____</p>
 <p>I am made from a cococut. I have 2 strings and you play me with a bow.</p>  <p>_____</p>	 <p>I am one of the most popular instruments in the world. I can be played with fingers or a plectrum</p>  <p>_____</p>
 <p>I have a keyboard and a foot controlled motor to play my strings.</p>  <p>_____</p>	 <p>I usually have 8 strings, generally played with a plectrum.</p>  <p>_____</p>